



EXTRASOFT (INDOOR + OUTDOOR)

design Piero Lissoni

Modular elements of different dimensions available for indoor and outdoor.

Indoor version: frame in double-paneled poplar and pine. Support in cross-woven coated rubber elastic straps. Padding in differentiated density polyurethane foam covered with a quilted mat in prewashed and sterilized goose down, stitched into separate compartments or, on request, padding in differentiated density polyurethane foam with a mat covered with acrylic fibre layers. Fabric or leather upholstery, both fully removable by Velcro fastenings.

Outdoor version: frame in steel lacquered for outdoor for bases and in steel lacquered for outdoor and plywood for outdoor for backrest and armrests. For bases only, support in cross-woven, coated rubber elastic straps and hooks in Stainless Steel for outdoor. Padding with open cell structure polyurethane foam DRYFEEL S, with a quilted mat in fibre for outdoor covered with waterproof fabric protection. Upholstery with outdoor fabrics only, fully removable by Velcro fastenings. Both versions are with black adjustable PVC feet. The various elements are joined together by means of hooks.
Seat depth: 68-94-120-134-146cm.

Notes

All elements can be ordered 5 to 10cm higher than standard.

On request, all indoor elements can be covered with the mat in acrylic fibre layers, instead of goose down.

On request can be ordered a spacer, to lift the elements of further 4cm, to be screwed to the standard feet.

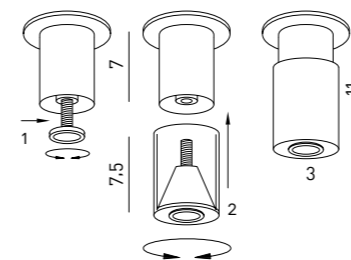

For the outdoor version it is recommended to place the elements on the floor; for placing the elements on the lawn it is recommended to use feet with spacers.

Furthermore, especially after rain or during period of high humidity, it is recommended to periodically separate the different elements and / or to temporarily lift the seat / backrest / armrest cushions to allow a complete drying of the same and to avoid the accumulation of dirt and humidity that might cause mildew. To improve the life of the product, it is also recommended to protect it with the "Outdoor Covering"; remember that this covering is water vapour repellent and prevents mould and corrosion. It can be washed with water and soap.

For the 146 cm armrests and the 146 cm and 172 cm backrests in patterned, flowered or structured fabric, velvet or leather, there is always a central seam. For the 146 cm seat element in fabric or leather, there is always a central seam; if this seat element is combined with a 146 cm backrest, this is also provided with a central seam.

The various elements are joined together by means of hooks, as per the instructions supplied with the product.

Hooks for assembly elements with standard feet in PVC.

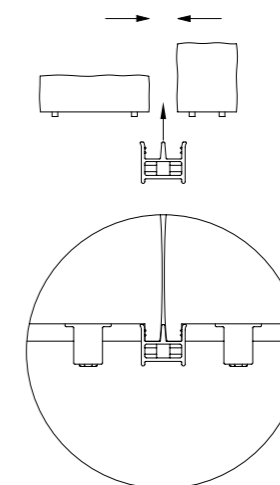

Hooks for assembly elements with feet with spacers.

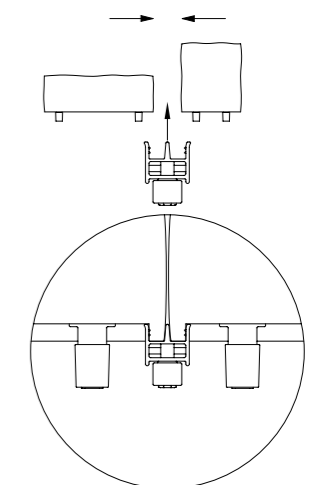

For composition with different elements, please attach a general sketch to the order.

Technical Drawings

Base

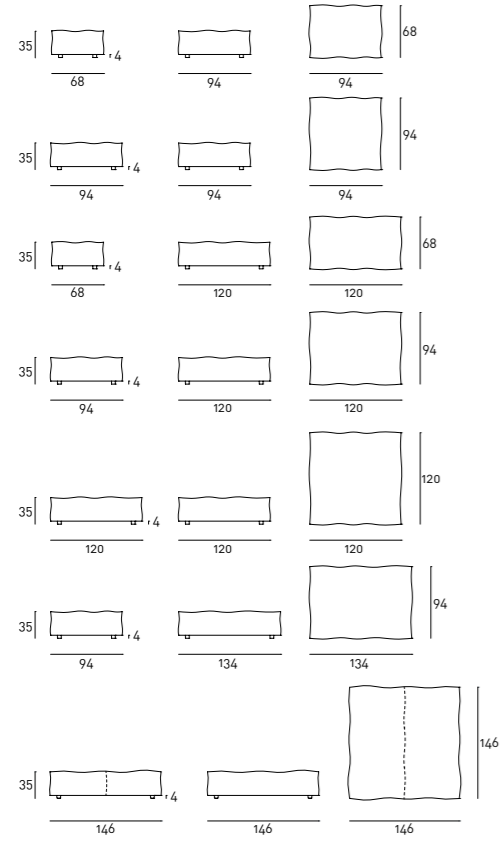

Loose Cushion

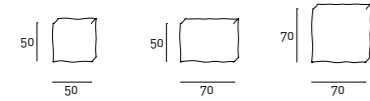

Armrest

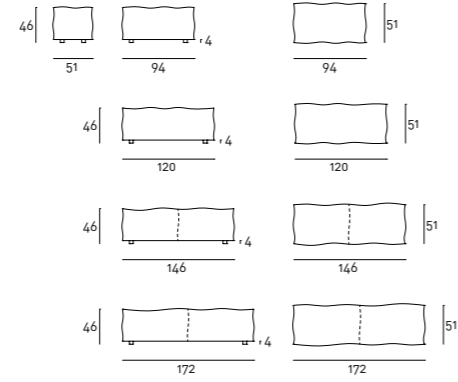

Backrest

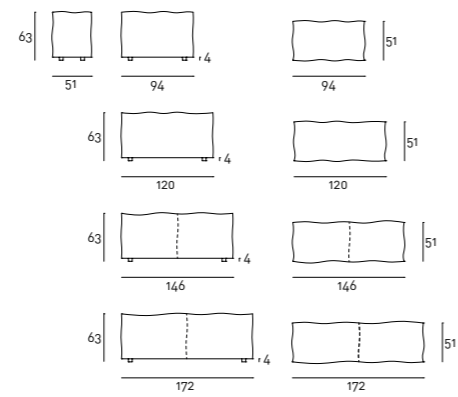

Examples of Composition

Composition 01

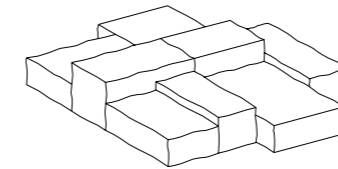
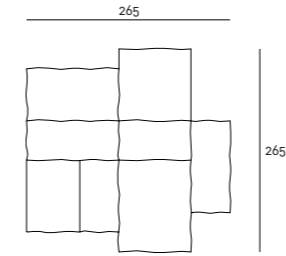

ESOE068 ESOB120A
 ESOE994 ESOB094A
 ESOE968 ESOB094B
 ESOE094 ESOB120B

Composition 03

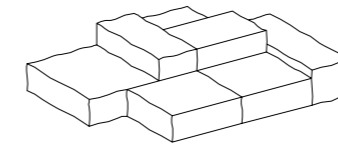
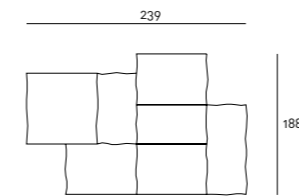

ESOE994 ESOB094A
 ESOE968 ESOB094A
 ESOE968 ESOB120B
 ESOE968

Composition 02

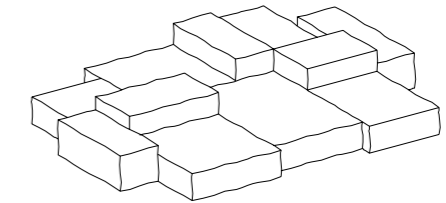
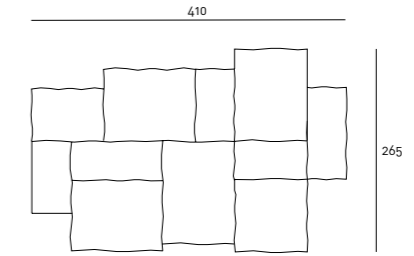

ESOE968 ESOB094B
 ESOE094 ESOB120A
 ESOE094 ESOB094A
 ESOE094 ESOB094A
 ESOE134 ESOB120B
 ESOE994

Composition 04

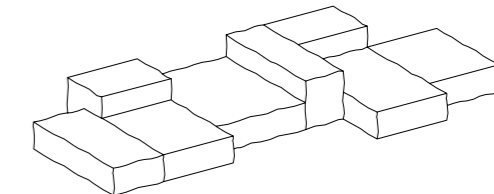
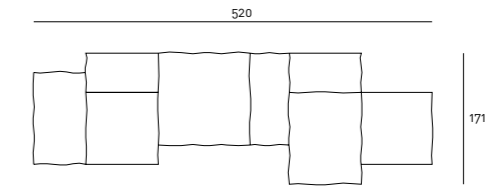

ESOE068 ESOE994
 ESOE994 ESOB094A
 ESOE120 ESOB120A
 ESOE094 ESOB094A

The commercial codes refer to the elements chosen in the above-proposed compositions.



